



Product Certification of
Surgical Glove:
Application for Certification



MALYSIAN RUBBER BOARD
Stesen Penyelidikan RRIM Sg. Buloh
Bangunan IRPEC, Lembaga Getah Malaysia
47000 Sungai Buloh, Selangor
Regulatory and Quality Assurance Unit
Tel: 03 – 6145 9400/9488
Fax: 03 – 6157 6525
Email: pcs@lgm.gov.my

1. Scope

- 1.1 Natural Rubber surgical glove intended for application in Malaysian Hospitals under MOH and cover for:
- a) Powdered
 - b) Powder Free

2. Product Certification System Type

- 2.1 MRB uses ISO System No. 5 as the certification scheme. Under this system, certification is granted only if the product meets with the specified standard and market surveillance to ensure continuous compliance with the standard.
- 2.2 The ISO System No. 5 involves types of testing and assessment of factory quality management system and its acceptance followed by surveillance that takes into account the assessment of factory Quality Management System (QMS) and testing of samples from the producer.

3. General Requirements of Certification

3.1 Application Certification Procedures

- 3.1.1 Surgical glove producer who wishes to have its product certified by MRB need to apply to the Product Certification Secretariat (PCS) by the application form through LGM official website (<https://pcos.lgm.gov.my/PCOS/Application.aspx>).
- 3.1.2 In addition to comply with the General rules governing the MRB Product Certification system (see Product Certification: MRB – PCB – 01: Rules Governing Rubber Product Certification), producers applying for certification are also required to conform to the following:
- a) Provide all necessary information required by the MRB for the purpose of evaluation of the product(s) to be certified. Applicants may be required to provide documentary proof that their productions are technically capable in meeting the specified surgical glove specification.
 - b) Provide documentary evidence that the certificate of quality management system (QMS) obtained from accredited certification body.
 - c) Pay all relevant application fees to the MRB.
 - d) Allow the MRB PC (Product Certification) inspector to collect samples for the evaluation process. There should be no interference on the part of the applicant in terms of how random samples are selected by the MRB PC inspector.
 - e) Samples may be taken at any point after packaging from the production line and samples may also be taken at export points or from the market.
 - f) While all information supplied by the applicant shall be treated with utmost confidentiality by the MRB, the applicant shall permit the MRB to use and release whatever information obtained in the course of the application to the public or

government authorities as deemed proper and necessary by the MRB, or as required by existing law or regulation.

- 3.1.3 On receipt of the application, the PCS will provide a written acknowledgement to the applicant, if all fees have been received and all information required is in order.
- 3.1.4 MRB will inform the applicant with regard to an inspection to the factory for the purpose of certification assessment. Satisfy with the assessment, the applicant shall be issued a certificate of conformity. There are maximum of three (3) re-assessment carried out during certification process, failing which, the applicant need to submit new application form together with the application fee.
- 3.1.5 The successful applicants shall also be permitted to use the MRB Conformity Mark on their product and/or packaging. The approved applicant shall be registered and added to the certified supplier list (which may be made public and each certification shall be address-specific).The Product Certification Committee (PCC) shall have access to this list at any time.
- 3.1.6 The detail of the certification process is shown in Appendix 1.

3.2 Product Sampling

- 3.2.1 In general, product sampling during inspection shall be randomly selected and sample shall be from the representative scope of application for certification, and current production. Gloves shall be sampled and inspected in accordance with ISO 2859-1.
- 3.2.2 The inspection levels and acceptable quality levels (AQLs) shall conform to those specified in Table 1 for the characteristics listed.

Table 1 - Inspection Levels and Acceptable Quality Levels (AQLs)

Characteristics	Inspection Level	AQL
Physical dimensions (width, length, thickness)	S-2	4.0
Water Tightness	G I	1.5
Tensile Properties	S-2	4.0
Powder Free Residue – Powder free	N=5	N/A
Proteins Content	N=3	N/A
Powder Amount – Powdered	N=2	N/A

- 3.2.3 Samples shall be taken from products that have been identified by the manufacturer as having “Passed internal QC”.

3.3 Product Testing

3.3.1 Dimension

3.3.1.1 The measurement of length shall be the shortest distance between the tip of the second finger and the cuff termination.

3.3.1.2 The measurement of width shall be at the midpoint between the base of the index finger and the base of the thumb. The width measurement shall be made with the glove placed on a flat surface.

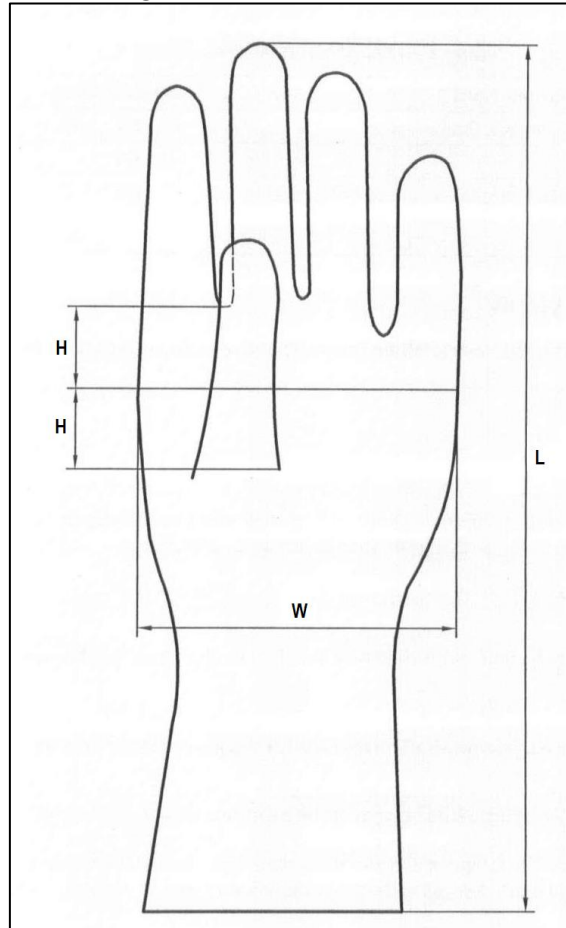

Figure 1: Measurement points for length and width

3.3.1.3 The thickness of the double wall of an intact glove shall be measured in accordance with ISO 23529, with a pressure on the foot of $22 \text{ kPa} \pm 5 \text{ kPa}$ at each of the locations shown in Figure 2: a point $13 \text{ mm} \pm 3 \text{ mm}$ from the extreme tip of the second finger, the approximate centre of the palm, and a point $25 \text{ mm} \pm 5 \text{ mm}$ from the cuff termination. The single-wall thickness at each point shall be reported as half the measured double-wall thickness.

3.3.1.4 If visual inspection indicates the presence of thin spots, then single-wall thickness measurements shall be made in such areas.

3.3.1.5 All samples shall be tested at laboratories which is accredited to ISO/IEC 17025.

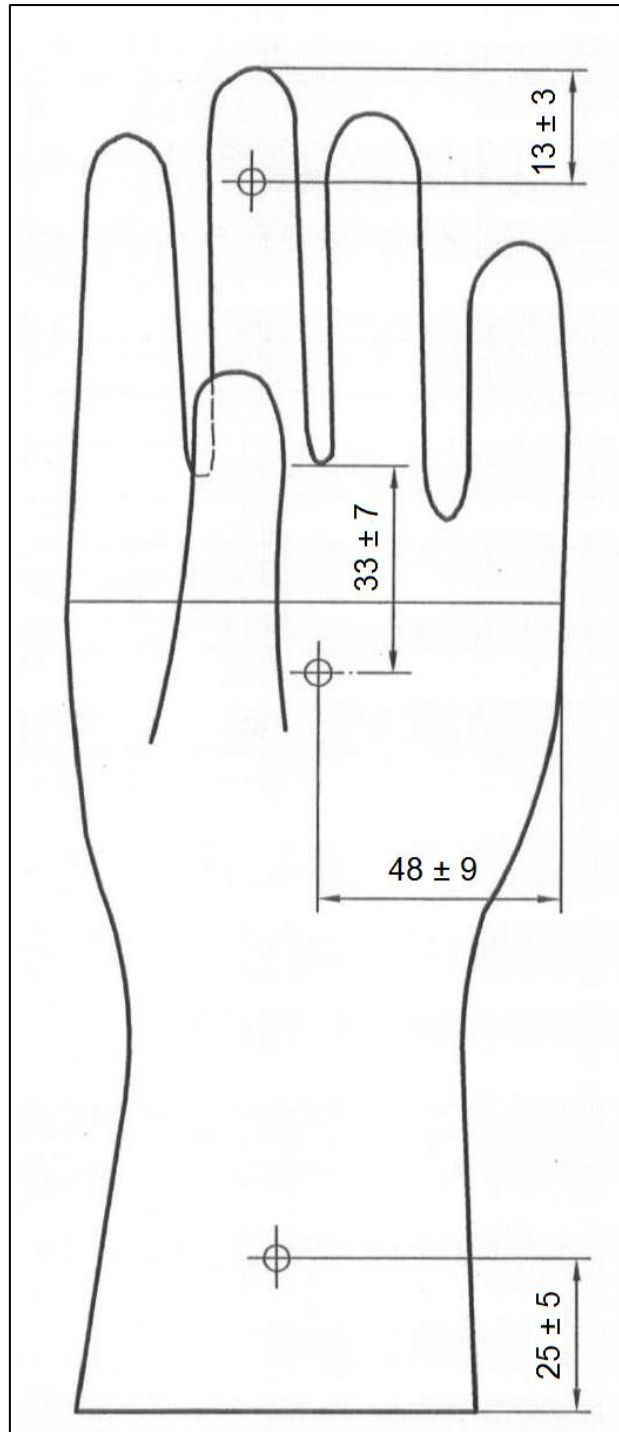

Figure 2: Measurement points for thickness

3.3.2 Watertightness

3.3.2.1 Apparatus

- a) **Cylinder hollow mandrel**, of minimum external diameter 60 mm and adequate length to hold the glove and, with the glove attached, to accommodate 1000 cm³ of water. An example is given in figure 3. It is useful if the mandrel is transparent.

- b) **Holding device**, designed to hold the glove in vertical position when filled with water. An example is given in figure 4.
- c) **Graduated cylinder**, capacity at least 1 000 cm³ or other dispensing apparatus capable of delivering 1 000 cm³ at a time.

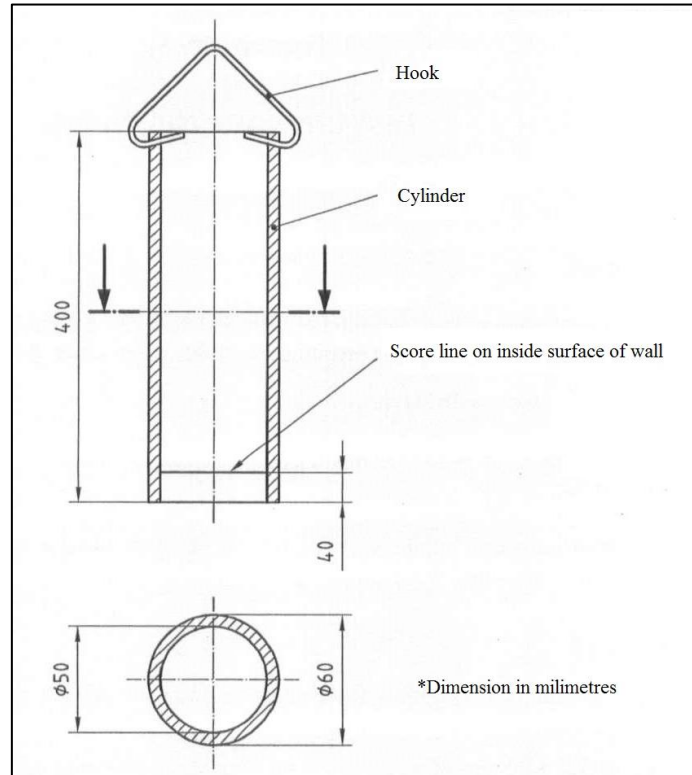

Figure 3: Mandrel design

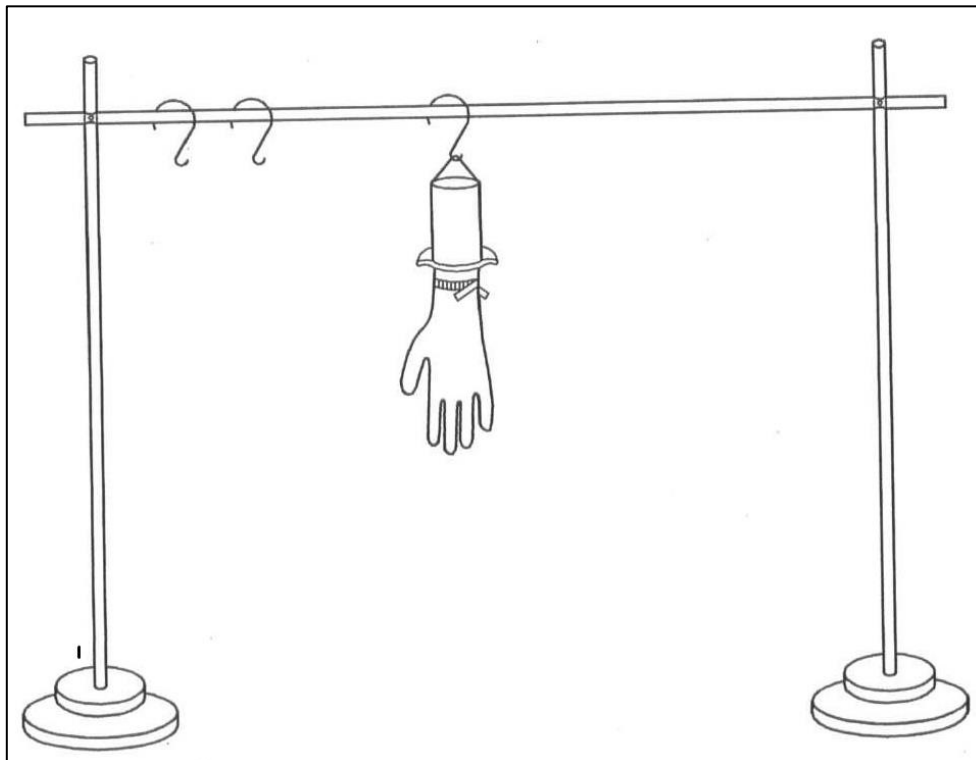

Figure 4: Holding device

3.3.2.2 Procedure

- a) Attach the glove to the circular hollow mandrel by a suitable device, e.g. an O-ring, so that the glove does not extend more than 40 mm over the mandrel.
- b) Introduce $1\ 000\ \text{cm}^3 \pm 50\ \text{cm}^3$ of water at a maximum temperature of $36\ ^\circ\text{C}$ into the device. Remove any water that has inadvertently splashed on to the glove. If the water does not rise to within 40 mm of the cuff end, raise the glove to ensure that the whole of the glove, excluding the part 40 mm from the cuff end, is tested.
- c) Note any leaks immediately evident. If the glove does not leak immediately, make a second observation for leaks 2 min to 4 min after pouring the water into the glove.
- d) Disregard leakage within 40 mm of the cuff end. To assist observation, the water can be coloured with a water-soluble dye.

3.3.2.3 All samples shall be tested at laboratories which is accredited to ISO/IEC 17025.

3.3.3 Tensile Properties

3.3.3.1 Tensile properties shall be measured in accordance with ISO 37, taking three type 2 dumb-bell test pieces from each glove and using the median value as the test result. Test pieces shall be taken from the palm or back of gloves.

3.3.3.2 Accelerated ageing tests shall be conducted in accordance with the method specified in ISO 188. After the test pieces cut from the gloves have been subjected to a temperature of $70\ ^\circ\text{C} \pm 2\ ^\circ\text{C}$ for $168\ \text{h} \pm 2\ \text{h}$.

3.3.3.3 Records the reading of following result:

- a) Minimum force at break before accelerated ageing
- b) Minimum elongation at break before accelerated ageing
- c) Maximum force required to produce 300 % elongation before accelerated ageing
- d) Minimum force at break after accelerated ageing
- e) Minimum elongation at break after accelerated ageing

3.3.3.3 All samples shall be tested at laboratories which is accredited to ISO/IEC 17025.

3.3.4 Powder Free Residue

3.3.4.1 For powder free residue, each of the samples collected shall be tested accordance to ASTM D 6124, Standard Test Method for Residual Powder on Medical Gloves.

3.3.4.2 A whole glove shall be used for the testing.

3.3.4.3 All samples shall be tested at laboratories which is accredited to ISO/IEC 17025.

3.3.5 Proteins Content

- 3.3.5.1 For proteins content, each of the samples collected shall be tested accordance to ASTM D 5712, Standard Test Method for Analysis of Aqueous Extractable Protein in Natural Rubber and its Products using the Modified Lowry Method.
- 3.3.5.2 A whole glove shall be used for the testing.
- 3.3.5.3 All samples shall be tested at laboratories which is accredited to ISO/IEC 17025.

3.3.6 Powder Amount

- 3.3.6.1 For powder amount, each of the samples collected shall be tested accordance to ASTM D 6124, Standard Test Method for Residual Powder on Medical Gloves.
- 3.3.6.2 A whole glove shall be used for the testing.
- 3.3.6.3 All samples shall be tested at laboratories which is accredited to ISO/IEC 17025

3.4 Requirement

3.4.1 Dimension

- 3.4.1.1 Sample gloves shall comply with the dimensions for palm width, thickness and length specified in Table 2 below, using the inspection and AQL indicated in Table 1.

Table 2 - Dimensions and tolerances

Size code	Width (dimension W, Figure 1) mm	Minimum length (dimension L, Figure 1) mm	Minimum Thickness (at the locations shown in Figure 2) mm
5	67 ± 4	250	For all sizes: Smooth area: 0.10 Textured area: 0.13
5.5	72 ± 4	250	
6	77 ± 4	260	
6.5	83 ± 5	260	
7	89 ± 5	270	
7.5	95 ± 5	270	
8	102 ± 6	270	
8.5	108 ± 6	280	
9	114 ± 6	280	
9.5	121 ± 6	280	

- 3.4.1.2 The thickness of the cuff termination measured in accordance with ISO 23529 should preferably not exceed 2.50mm.

3.4.2 Watertightness

3.4.2.1 The sample size and allowable of non-conforming (leaking) gloves in the sample shall be determined in accordance with the inspection level and AQL given in table 1.

3.4.3 Tensile Properties

3.4.3.1 Sample gloves shall comply with the tensile properties specified in Table 3 below, using the inspection and AQL indicated in Table 1.

Table 3 -Tensile properties

Properties	Requirement
Minimum force at break before accelerated ageing, N	12.5
Minimum elongation at break before accelerated ageing, %	750
Maximum force required to produce 300 % elongation before accelerated ageing, N	2.0
Minimum force at break after accelerated ageing, N	9.5
Minimum elongation at break after accelerated ageing, %	560

3.4.4 Extractable Proteins and Residual Powder Content

3.4.4.1 Sample gloves shall comply with the extractable proteins, residual powder content and antigenic protein content specified in Table 4 below.

Table 4 - Extractable proteins, residual powder content and antigenic protein content

Properties	Requirement	
	Powder Free	Powdered
Powder Free Residue, mg/glove	< 2	-
Protein Content, µg/dm ²	< 50	< 200
Powder Amount, mg/glove	-	< 15

3.5 Sterility

3.5.1 Gloves shall be sterilized. The nature of sterilization process shall be disclosed on request such as process qualification report namely operational qualification and performance qualification.

3.6 Surveillance Inspection

3.6.1 Successful certified producers shall be subjected to the MRB surveillance program, which will be carried at least twice a year. All surveillance shall be announces and producer need to inform MRB on the availability of certified surgical glove.

3.6.2 Samples are to be marked by the MRB PC inspector personnel and sent to the laboratories.

3.6.3 All test results of the surveillance inspection will be sent to the producer. If the batch pass the specifications, it can be distributed as MRB certified surgical glove.

- 3.6.4 Any failure will cause the producer to receive a warning letter. The production which fail the test will be rejected. The producer shall immediately cease to label affected product with the Certification Mark and not made any further reference to its certified status. Producer shall take necessary corrective action and submit the report to MRB for verification.
- 3.6.5 Any producer whose product does not meet the technical specification after the verification inspection shall face the consequences of termination of certification.
- 3.6.6 The production which has been sampled under surveillance inspection shall be excluded from routine inspection procedures.
- 3.6.7 Detail of MRB surgical glove surveillance inspection process flow can be referred to Appendix 2.
- 3.6.8 Ad-hoc surveillance visits may be conducted if there is reason to believe that a certified manufacturer has not fully controlled its production processes. Samples may be taken for additional testing and appropriate action taken based on observation during such visits and test results.
- 3.6.9 The manufacturer shall be responsible to inform MRB immediately should any major NC raised in the QMS audits and suspension or withdrawal has been imposed by Certification Body of QMS.

3.7 Routine inspection

- 3.7.1 Successful certified producers shall be subjected to conduct routine inspection to all certified surgical glove produced to ensure continuous compliance with the specified standards.
- 3.7.2 The sampling and testing method shall follow as stated in 3.2 and 3.3.
- 3.7.3 A copy of all test results shall be sent to MRB for verification and reference purposes.
- 3.7.4 The batch which fail the test will be rejected and shall immediately cease to label affected product with the Certification Mark and not made any further reference to its certified status. Producer shall take necessary corrective action and submit the report to MRB for verification.
- 3.7.5 Detail of MRB Surgical Glove routine inspection flow can be referred to Appendix 3.

3.8 Market Surveillance

- 3.8.1 Market surveillance will be conducted at least once a year and any charges incurred will be charged to the producer accordingly. The sample will be taken within 1 year after manufacturing date.
- 3.8.2 If fail, the producer will be notified and shall provide explanation (on investigation of root cause, corrective and preventive action taken) within 14 days failing which, the certification status will be terminated and a recall system shall be activated by the producer.
- 3.8.3 Detail of MRB Surgical Glove Market Surveillance flow can be referred to Appendix 4.

4. Amendment to Scope of Certification

- 4.1 A certified producer may at any time make a formal application to the MRB to amend its scope of certification, e.g. increase/reduction of scope, using the appropriate form (refer Appendix 5) available from the Product Certification Secretariat. The MRB will decide on the action necessary in response to the request, which may require a new or additional evaluation. The application shall be informed in writing on the action taken by the MRB regarding the application.

5. Use of the Mark of Conformity

- 5.1 Certified producers are permitted to use Mark of Conformity on their products and/or product packaging (where appropriate) and make reference to their certified status. The mark detailing the information of the producer and demonstrate that such products meet with specified standard(s)/specifications.
- 5.2 Where practicable, Mark of Conformity shall be reproduced in the form as detailed in Figure 5. Any enlargements or reductions shall retain the same proportions but shall be sufficiently large for the wording to be clearly legible.
- 5.3 Mark of Conformity may be imposed on products and/or their smallest units of packaging (where appropriate) in whichever manner deemed practicable, and shall be applied together with certification code to whom the product is certified to.



Figure 5: Mark of Conformity

6. Packaging

- 6.1 Glove shall be packaged in sequential two-layered packaging.
- 6.2 Every packaging shall be identified, traceable and marked as indicated in Figure 3.
- 6.3 Inner packages shall be clearly marked/printed with the following:
- a) Size of glove
 - b) Designation "left" or "L" or "right" or "R" on the package.
 - c) Manufacturing date
 - d) Lot number

7. Suspension of Certification Status

7.1 The certification may be suspended for a limited period which shall be determined by the Director General, as advised by the Product Certification Panel (PCP), under the following circumstances:-

- a) when a factory fails a surveillance, and is not able to take corrective action within a month of being notified of its short-coming.
- b) non-compliance with the technical specification. Corrective actions may include re-inspection/re-testing of the surgical gloves and removal of mark of conformity prior to shipment from the factory.
- c) improper use of the certificate or mark of conformity, e.g. in misleading prints, advertisement, promotional materials or other literature. Corrective actions may include the amendment or discontinuance of such advertising promotional material.
- d) failure to furnish samples as may be required by the MRB for examination and testing purposes.
- e) obstructing the immediate access by the PC Inspector of the MRB to the factory or warehouse premises covered by the certificate during the working hours of the factory.
- f) failure to provide co-operation to facilitate the inspection of records by the PC Inspector.
- g) non-payment of the annual fees to the MRB.
- h) failure to pay costs of testing.

8. Cancellation and Withdrawal of the Certificates

8.1 Apart from the suspension of a certificate, a certificate may be withdrawn in the following cases:-

- a) Fails a surveillance, and is not able to take comprehensive corrective action within three (3) months of first being notified of its short-coming.
- b) Non-compliance is of a serious nature
- c) Certificate holder fails to comply with due settlement of his financial obligations
- d) Inadequate measures taken by the certificate holder in the case of suspension
- e) Legal action on the misuse of the MRB certification by a third party
- f) No person shall use the MRB logo unless the person holds a valid certificate issued by the MRB.
- g) A person who contravenes the above rule shall be guilty of an offence and shall be subjected to the Trade Descriptions Act 1972 (Act 87).

- 8.2 If the certification of a product is terminated (cancelled/withdrawn), the following actions shall be undertaken immediately by the producer:
- a) The producer shall immediately cease to label any product with the Mark of Conformity and certification code and not made any further reference to its certified status.
 - b) The producer shall surrender the valid certificate to the MRB.
 - c) The MRB has the right to publicise the name of product (and its producer) which has been suspended or has its certified status withdrawn. Likewise, the MRB will notify when suspension on a particular product (producer) has been lifted.
- 8.3 The MRB reserves the right to take appropriate action, including legal ones, against any producer who violates the above rules during the period of certification, or after the certification has been withdrawn.

9. Contract Manufacturing

- 9.1 Where a certified manufacturer purchases/acquires surgical gloves from another manufacturer to sell as part of its own production/shipment as MRB certified product, the supplying manufacturer must also be a certified by MRB.

10. Certificate validity

- 10.1 Certificate will be renew annually. The renewal will be based on the test result which will be carried out at least twice a year.

11. Charges

- 11.1 The certification shall be charged by the certification body as per Appendix 6.

Attachment 1: Flow Chart of Certification Process for Surgical Glove Certification Program

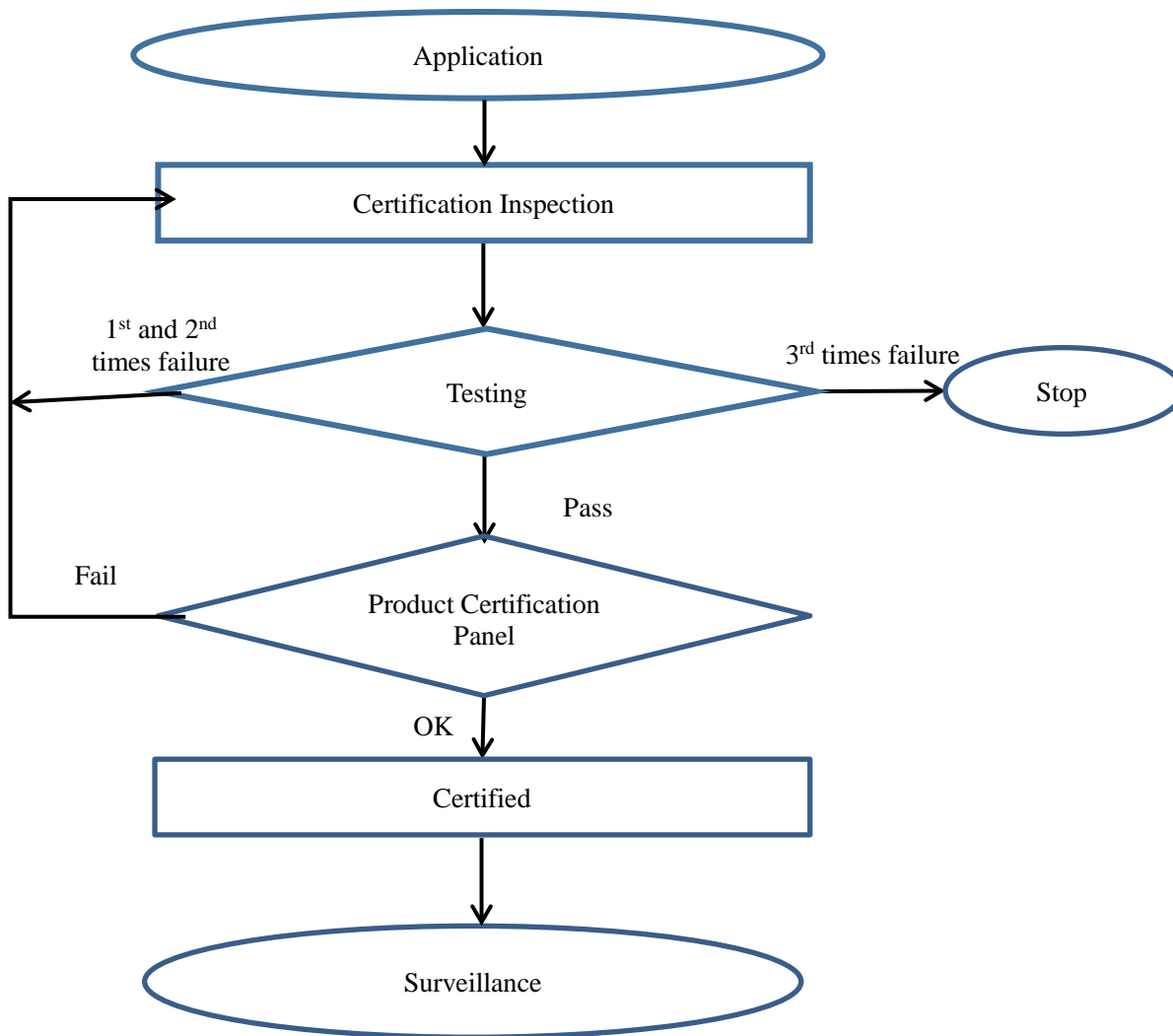

Attachment 2: Flow Chart of Surveillance Inspection for Surgical Glove Certification Program

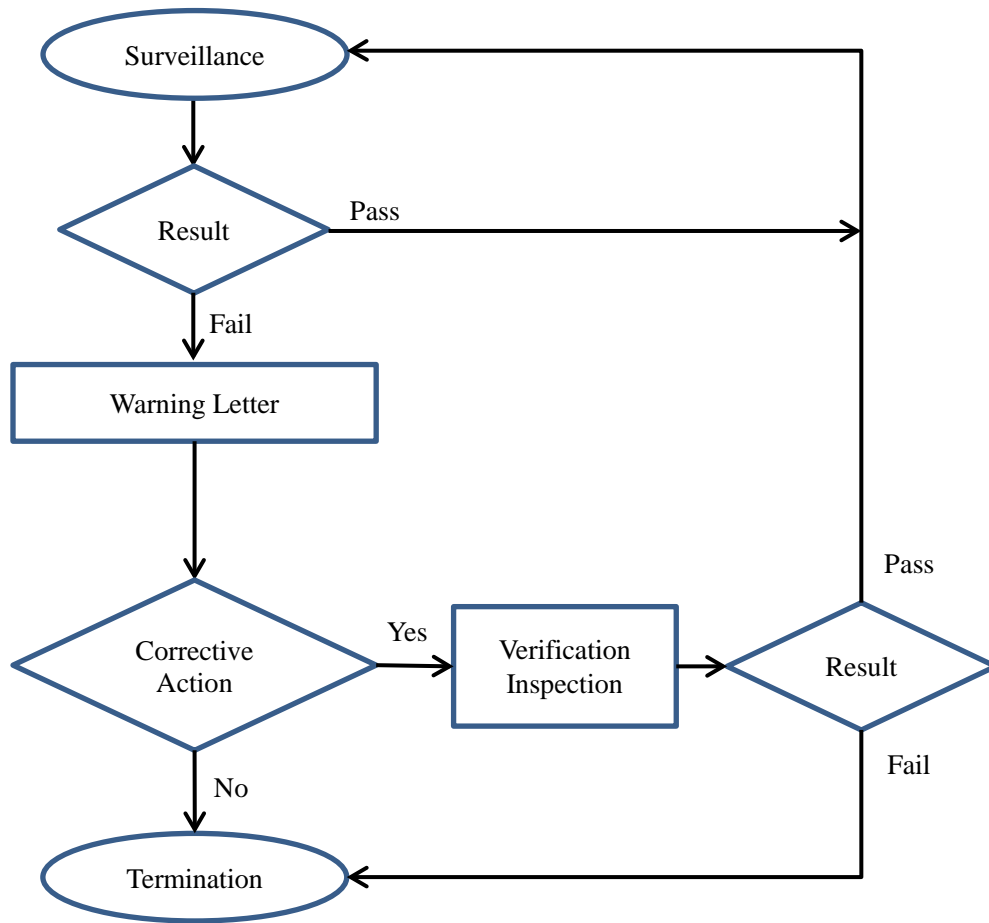

Attachment 3: Flow Chart of Routine Inspection for Surgical Glove Certification Program

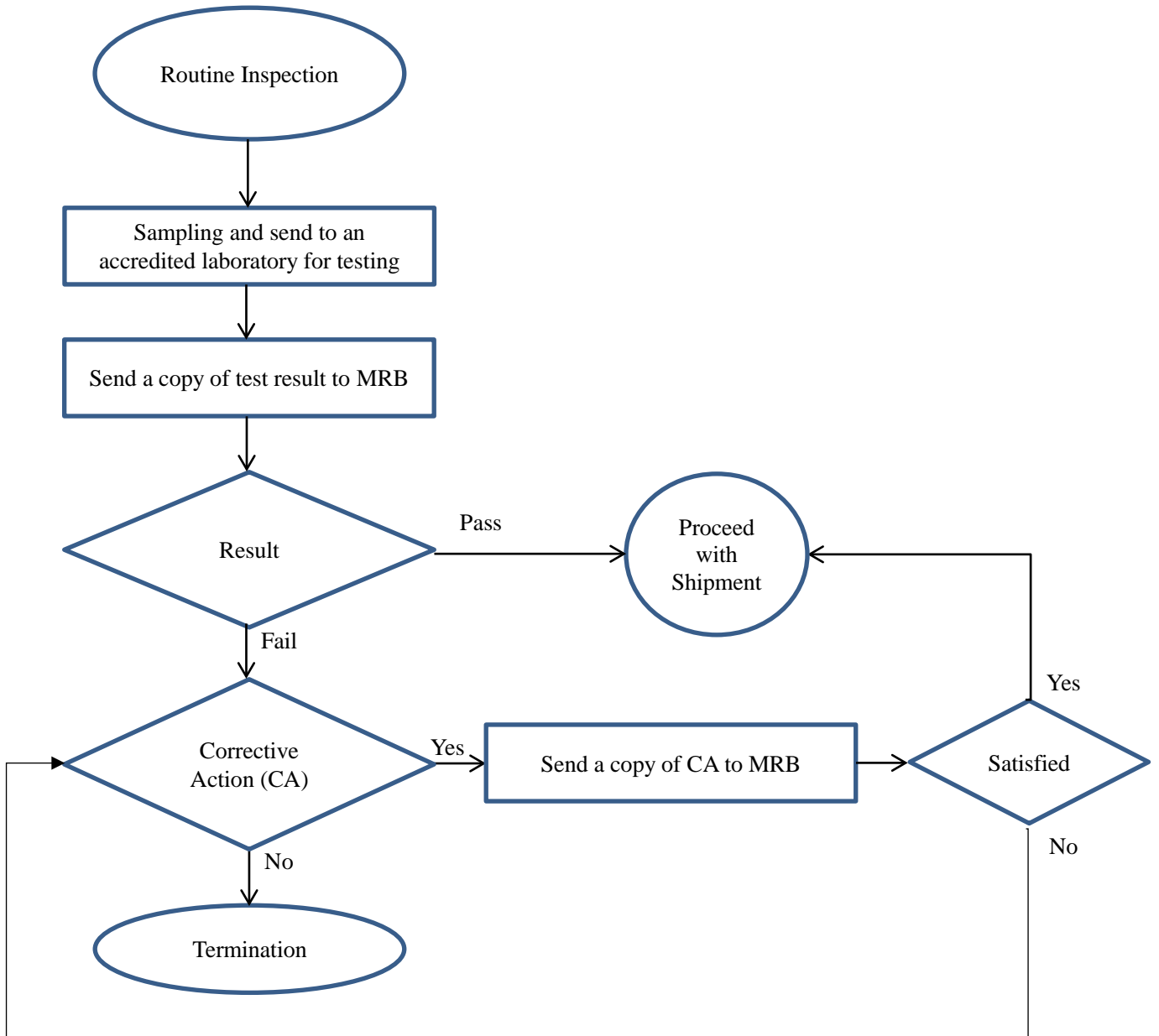

Attachment 4: Flow Chart of Market Surveillance for Surgical Glove Certification Program

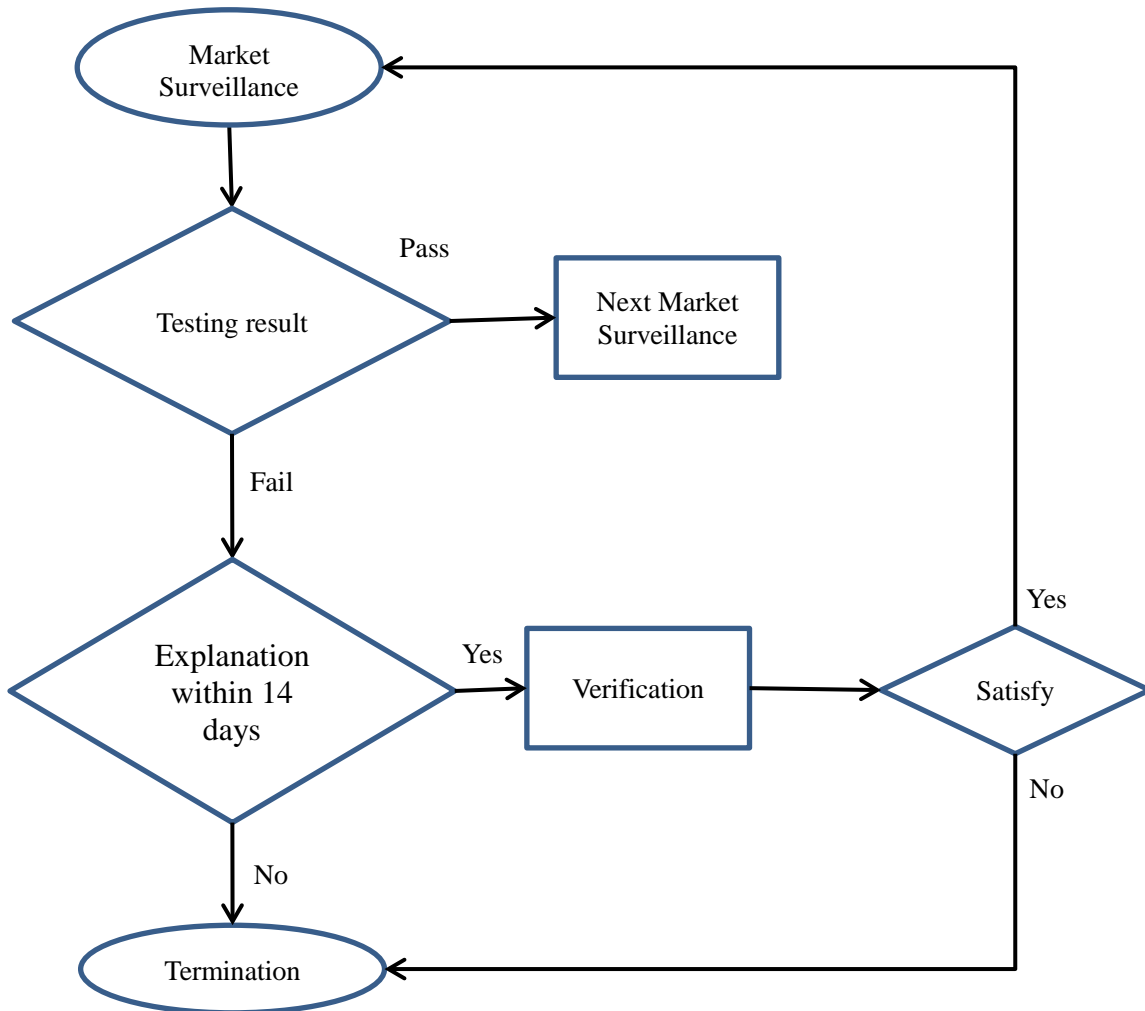

MALAYSIAN RUBBER BOARD Product Certification Program

Application for Change (extension/reduction) of Scope of Certification

Name of Certified Producer:

Address:
.....
.....

Contact Person:

Designation:

Tel: Fax:

Current scope of certification	Scope of certification sought/ reduced

Signature: Date:

=====

FOR OFFICE USE ONLY

Received Date :

- 1. Client information is sufficient ()Yes ()No
- 2. Product information is sufficient ()Yes ()No
- 3. No difference in understanding between the MRB and the Client ()Yes ()No
- 4. The scope of certification sought is defined ()Yes ()No
- 5. The means are available to perform all evaluation activities ()Yes ()No
- 6. MRB has the competence and capability to perform the certification activity. ()Yes ()No

Reviewed by:

Approved by :

Date of Inspection :

Team leader/ PC Inspector :

Attachment 6: Fees and Cost of Testing for Surgical Glove

FEEES PAYABLE

- One time application fee
 - RM 3,000.00

- Inspection fee (2 inspectors)
 - Peninsular Malaysia : RM 1,250.00/ inspection
 - Sabah/ Sarawak : RM 1,250.00/ inspection excluding travelling (aviation, land and maritime) and accommodation

- Renewal fee for each certificate per year (payable annually one year after the issuance of Product Certification)
 - RM 500.00/ certificate

- Testing fee
 - RM 3000.00/ lot sampled

- Market Surveillance
 - Cost of sample taken : based on price of product
 - Travelling for sample taken : RM 1,250.00
 - Testing fee : RM RM 3,000.00/ lot sampled